

Data Sheet



Article number: 12621000300000

Description: Industrial tool 621 000 300.000
For M30

Measures

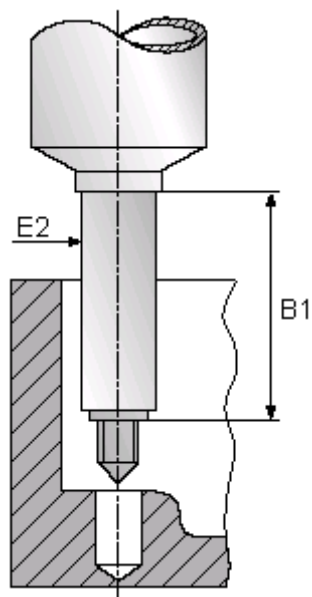

B1	= 60
E2	= 38
For thread = M30	